



Omastream
embrace your space

CATALOGUE
MONARCH RETRACTABLE SCREENS

SEIKI
SCREEN SYSTEMS™



MAKING
LIFE
BETTER

WHAT WE VALUE

At Omastream, our purpose is to enhance lives for our team and customers while advancing the screen industry within New Zealand. We are committed to embracing architectural innovation and improving home spaces for enjoyable lifestyles.

We source innovative products globally for the New Zealand market, offering stunning designs and thermal efficiency within this range.

Our expertise stems from experience and a strong understanding of local and international markets, along with a commitment to exceptional service.



Omastream
embrace your space

CONTENTS

4	INTRODUCTION
5	WARRANTY STATEMENT
6	PRODUCT OVERVIEW
	Monarch EX2
	Monarch Glide
	Monarch Lite
	Monarch Window
14	SCREEN SELECTION
15	HOW TO MEASURE
16	EXTRUSION PROFILES
	Monarch EX2
	Monarch Glide
	Monarch Lite
	Monarch Window
19	SPARE PARTS
	Monarch Glide
	Monarch Window
	Monarch EX2
20	FACE MOUNT ATTACHMENT
	FMA3Sided
	FMA4Sided
22	TECHNICAL SPECIFICATIONS
23	OWNERS MANUAL

INTRODUCTION

Retractable insect screens are gaining popularity as consumers seek solutions for natural ventilation and energy efficient ways to keep their home comfortable and insect free. The use of retractable fly screens allows building designers and homeowners to incorporate unconventional sized openings to the building design, providing increased ventilation, a greater sense of space and connection with the outside environment with maximum insect protection.

Retractable screens are aesthetically pleasing and visible when in use offering uninterrupted views and convenient access in and out of the home.



Screens are installed on the inside or outside of windows or doors depending on their application and do not permanently cover the opening or detract from elegant feature doors.

In today's world of combining indoor and outdoor living environments, retractable insect screens are a perfect inclusion for screening kitchens and alfresco areas.

Retractable insect screens decrease the amount of dust and other airborne pollutants in your home. When not in use the mesh screen is neatly parked in compact housing at the top or side of the opening.

The housing protects the mesh, reduces dust build up making for a cleaner environment in the home compared to permanently fixed insect screens.



The Monarch range of retractable screens by Seiki are the market leader in providing an extensive and diverse range of technologically advanced pleated insect screening solutions to suit any living environment.

PRODUCT OVERVIEW

MONARCH EX2

Low profile sill pleated retractable insect screen

Horizontal slide - manually operated

Applications

- Entry Doors
- French Doors
- Bifold Doors
- Stacker Doors
- Sliding Doors

Features

- 3mm high Floor Guide
- Retractable mesh guide system
- 20mm PET pleat
- Barrier free sill
- +/- 10mm building tolerance
- Smooth and easy to open and close
- Unique Mesh retention clips
- Supplied fully ready made or size adjustable kit

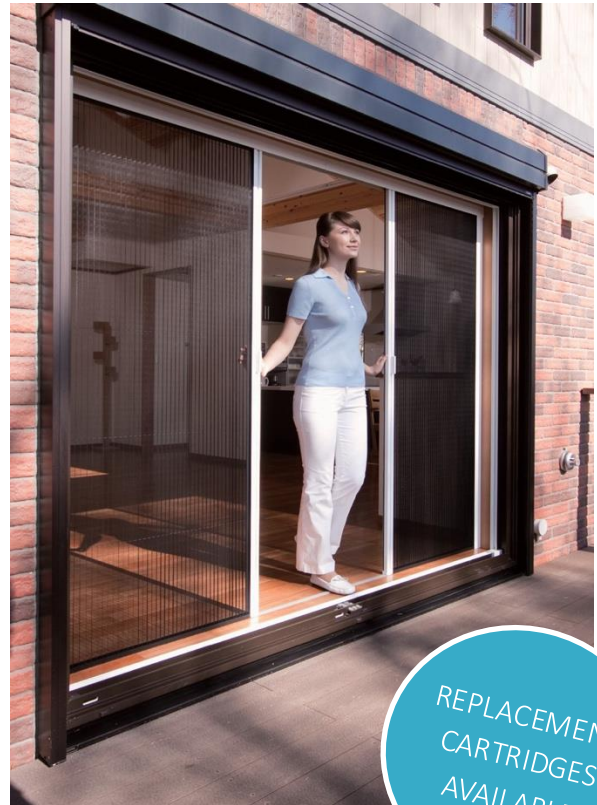

REPLACEMENT
CARTRIDGES
AVAILABLE

Overview

Monarch EX2 is possibly the most innovative retractable screening system on the market providing the perfect solution for screening Sliding, French and Bifold Doors. The revolutionary pleated retractable screen incorporates the industry first "Barrier Free Threshold".

The floor guide is just 3mm high and combined with the unique retracting mesh guide, it eliminates the trip hazard associated with traditional retractable insect screens. Optional mesh retention clips are installed top and bottom of the mesh keeping the mesh in place in windy conditions.

The screen is smooth and easy to operate as there are no tension springs or counterbalances used. The sliding bar stops at any position along the opening without the need of a brake or locking system. Monarch EX2 is predominantly suited for recess mount applications inside the door frame or the reveal of the opening. The screen is equally suited for face mounting using various build-out adaptors.

Size Range

Single Slide **Max:** 2600mm high x 2000mm wide
3000mm high x 1350mm wide

Double Slide **Max:** 2600mm high x 4000mm wide
3000mm high x 2700mm wide



****PLEASE NOTE THAT THE SCREEN MUST BE 60MM GREATER THAN THE WIDTH OF OPENING****

ORDERING INFORMATION

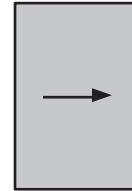

Single Panel

MONARCH EX2

SINGLE SPAN						
Width \ Height	701-900	901-1100	1101-1300	1301-1500	1501-1700	1701-2000
1651-1900	MXS-1909	MXS-1911	MXS-1913	MXS-1915	MXS-1917	MXS-1920
1901-2200	MXS-2209	MXS-2211	MXS-2213	MXS-2215	MXS-2217	MXS-2220
2201-2450	MXS-2409	MXS-2411	MXS-2413	MXS-2415	MXS-2517	MXS-2420
2451-2700	MXS-2709	MXS-2711	MXS-2713	MXS-2715	MXS-2717	MXS-2720
2701-2950	MXS-2909	MXS-2911	MXS-2913	*	*	*

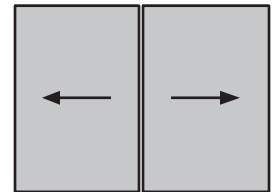

Double Panel

DOUBLE SCREEN						
Width \ Height	1401-1800	1801-2200	2201-2600	2601-3000	3001-3400	3401-4000
1651-1900	MXD-1918	MXD-1922	MXD-1926	MXD-1930	MXD-1934	MXD-1940
1901-2200	MXD-2218	MXD-2222	MXD-2226	MXD-2230	MXD-2234	MXD-2240
2201-2450	MXD-2418	MXD-2422	MXD-2426	MXD-2430	MXD-2534	MXD-2440
2451-2700	MXD-2718	MXD-2722	MXD-2726	MXD-2730	MXD-2734	MXD-2740
2701-2950	MXD-2918	MXD-2922	MXD-2926	*	*	*

STANDARD FINISHES: MF - Mill Finish
BK - Satin Black
WH - White

ORDERING CODE: S Single
D Double Slide

NOTES: *Size not available
Other sizes are available but may not be represented above.
Some sizes in this range may not be possible as height must be 60mm greater than width
Size may NOT be stocked – May be “Order In”
Custom colours available on request but subject to conditions.

PRODUCT OVERVIEW

MONARCH GLIDE

Wide span pleated retractable insect screen

Horizontal slide - manually operated

Applications

- Bifold doors
- Stacker Doors
- Large Sliding Doors

Features

- Pleated Pet Mesh 25mm Pleat
- +/- 5mm building tolerance
- Wide span capability
- Recess mount or Face mount with FMA
- Mesh retention clips
- Easy clean floor guide
- Quick to install
- Sliding Bar auto-stop
- Smooth and easy to open and close
- Supplied ready made or size adjustable kit



Overview

This modern stylish pleated screen is perfect for Bifold doors, stackers, large sliding doors, outdoor rooms or on openings that are more than 4.0m wide. The semi-transparent mesh is designed to maximize ventilation without compromising the view.

Monarch Glide incorporates Seiki's wide screen technology, allowing the screen to span greater distance than Monarch Ex2 but still maintain a high level of insect protection. It operates easily, allowing the user to gently slide the screen to any position along the opening due to the unique cord operating system.

The cords assist the motion of the screen and combined with Seiki's originally designed mesh retention clips support the mesh in windy conditions. When not in use, the mesh stores almost invisibly off to the side of the opening inside the cartridge.

Size Range

Single Slide **Max:** 3000mm high x 4600mm wide

Double Slide **Max:** 3000mm high x 9200mm wide

ORDERING INFORMATION

MONARCH GLIDE

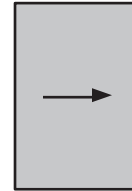

Single Panel

SINGLE SCREEN									
Width \ Height	1701-1900	1901-2200	2201-2500	2501-2800	2801-3100	3101-3400	3401-3800	3801-4200	4201-4600
1700 - 1950	MGS-1919	MGS-1922	MGS-1925	MGS-1928	MGS-1931	MGS-1934	MGS-1938	MGS-1942	MGS-1946
1951 - 2200	MGS-2219	MGS-2222	MGS-2225	MGS-2228	MGS-2231	MGS-2234	MGS-2238	MGS-2242	MGS-2246
2251 - 2450	MGS-2419	MGS-2422	MGS-2425	MGS-2428	MGS-2431	MGS-2434	MGS-2438	MGS-2442	MGS-2446
2451 - 2700	MGS-2719	MGS-2722	MGS-2725	MGS-2728	MGS-2731	MGS-2734	MGS-2738	MGS-2742	MGS-2746
2701 - 2950	MGS-2919	MGS-2922	MGS-2925	MGS-2928	MGS-2931	MGS-2934	MGS-2938	MGS-2942	MGS-2946

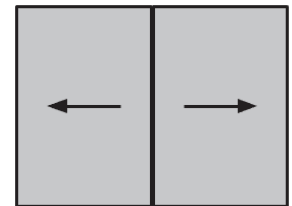

Double Panel

DOUBLE SCREEN									
Width \ Height	3401-3800	3801-4400	4401-5000	5001-5600	5601-6200	6201-6800	6801-7600	7601-8400	8401-9200
1700 - 1950	MGD-1938	MGD-1944	MGD-1950	MGD-1956	MGD-1962	MGD-1968	MGD-1976	MGD-1984	MGD-1992
1951 - 2200	MGD-2238	MGD-2244	MGD-2250	MGD-2256	MGD-2262	MGD-2268	MGD-2276	MGD-2284	MGD-2292
2251 - 2450	MGD-2438	MGD-2444	MGD-2450	MGD-2456	MGD-2462	MGD-2468	MGD-2476	MGD-2484	MGD-2492
2451 - 2700	MGD-2738	MGD-2744	MGD-2750	MGD-2756	MGD-2762	MGD-2768	MGD-2776	MGD-2784	MGD-2792
2701 - 2950	MGD-2938	MGD-2944	MGD-2950	MGD-2956	MGD-2962	MGD-2968	MGD-2976	MGD-2984	MGD-2992

STANDARD FINISHES: MF - Mill Finish
BK - Satin Black
WH - White

ORDERING CODE: S Single
D Double Slide

NOTES: Other sizes are available but may not be represented above.
Size may NOT be stocked – May be “Order In”
Custom colours available on request but subject to conditions.

PRODUCT OVERVIEW

MONARCH LITE

Wide Span Pull Down and Horizontal Sliding Screen

Horizontal and Vertical sliding screen - manually operated

Applications

- Serveries windows
- Bifold window
- Awning windows
- Sliding Doors

Features

- 20mm monofilament PE+PP mesh
- Face mount or recess mount installation
- Vertical & Horizontal Sliding
- Smooth Operation
- No springs or counter-balances
- Stops at any position along the opening
- Simple fast assembly and installation
- Easy to adjust cord tensioning
- Cords are fully guided over stainless steel rollers



Overview

This versatile pleated mesh retractable screen is developed specifically for wide span awning windows, bi-fold serveries and sliding doors. Sight lines are minimal due to the 20mm pleated mesh. The slim-line powder coated or anodized Aluminium frame is just 30mm wide making the screen ideal for installation to existing windows and doors. The screen is available as vertical pull-down or traditional horizontal sliding.

Monarch Lite is predominately designed as a recess mounted system, providing fast, easy, one-person installation. This also allows extrusion profiles to be rebated/recessed into the window and door frame as an integrated screening solution.

Installation is by way of screw fixing individual extrusions into position which is ideal for maintenance and or installation of new mesh if required. For applications where there is no room to install a screen inside the reveal / recess, a face mounted option using high bonding double side tape is available as a special order.

Size Range

Pull Down 2000mm high x 1350mm wide
 1500mm high x 1800mm wide
 1100mm high x 2400mm wide

Single Slide 2600mm high x 2500mm wide
Double Slide 2600mm high x 5000mm wide

Other size configurations possible if size is no more than 2.7sqm in total

ORDERING INFORMATION

MONARCH LITE

VERTICAL SASH – PULL DOWN							
Width Height	501-750	751-1000	1001-1250	1251-1500	1501-1750	1751-2000	2001-2250
771-970	MLP-0907	MLP-0910	MLP-0912	MLP-0915	MLP-0917	MLP-0920	MLP-0922
971-1170	MLP-1107	MLP-1110	MLP-1112	MLP-1115	MLP-1117	MLP-1120	MLP-1122
1171-1370	MLP-1307	MLP-1310	MLP-1312	MLP-1315	MLP-1317	*	*
1371-1570	MLP-1507	MLP-1510	MLP-1512	MLP-1515	*	*	*
1571-1770	MLP-1707	MLP-1710	MLP-1712	MLP-1715	*	*	*
1771-1970	MLP-1907	MLP-1910	MLP-1912	*	*	*	*
1971-2170	MLP-2107	MLP-2110	MLP-2112	*	*	*	*
2171-2370	MLP-2307	MLP-2310	*	*	*	*	*



Pull Down

SINGLE SASH HORIZONTAL SLIDING								
Width Height	771-970	971-1170	1171-1370	1371-1570	1571-1770	1771-1970	1971-2170	2171-2370
1001-1250	MLS-1209	MLS-1211	MLS-1213	MLS-1215	MLS-1217	MLS-1219	MLS-1221	MLS-1223
1251-1500	MLS-1509	MLS-1511	MLS-1513	MLS-1515	MLS-1517	MLS-1519	MLS-1521	MLS-1523
1501-1750	MLS-1709	MLS-1711	MLS-1713	MLS-1715	MLS-1717	MLS-1719	MLS-1721	MLS-1723
1751-2000	MLS-2009	MLS-2011	MLS-2013	MLS-2015	MLS-2017	MLS2019	MLS-2021	MLS-2023
2001-2250	MLS-2209	MLS-2211	MLS-2213	MLS-2215	MLS-2217	MLS-2219	MLS-2221	MLS-2223
2251-2500	MLS-2509	MLS-2511	MLS-2513	MLS-2515	MLS-2517	MLS-2519	MLS-2521	MLS-2523

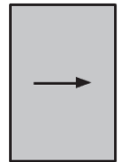

Single Panel

DOUBLE SASH HORIZONTAL SLIDING								
Width Height	1541-1940	1941-2340	2341-2740	2741-3140	3141-3540	3541-3940	3941-4340	4341-4740
1001-1250	MLD-1219	MLD-1223	MLD-1227	MLD-1231	MLD-1235	MLD-1239	MLD-1243	MLD-1247
1251-1500	MLD-1519	MLD-1523	MLD-1527	MLD-1531	MLD-1535	MLD-1539	MLD-1543	MLD-1547
1501-1750	MLD-1719	MLD-1723	MLD-1727	MLD-1731	MLD-1735	MLD-1739	MLD-1743	MLD-1747
1751-2000	MLD-2019	MLD-2023	MLD-2027	MLD-2031	MLD-2035	MLD-2039	MLD-2043	MLD-2047
2001-2250	MLD-2219	MLD-2223	MLD-2227	MLD-2231	MLD-2235	MLD-2239	MLD-2243	MLD-2247
2251-2500	MLD-2519	MLD-2523	MLD-2527	MLD-2531	MLD-2535	MLD-2539	MLD-2543	MLD-2547

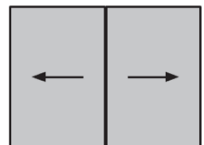

Double Panel

STANDARD FINISHES: MF - Mill Finish
BK - Satin Black
WH - White

ORDERING CODE: P Pull down 3 side frame
S Single Slide
D Double Slide

NOTES: *Size not available. Custom colours available on request but subject to conditions.

PRODUCT OVERVIEW

MONARCH WINDOW

Narrow frame pleated retractable insect screen

Horizontal and Vertical slide manually operated

Applications

- Double Hung windows
- Sliding windows
- Awning & Casement windows
- Bifold doors
- Servery windows

Features

- 15mm PP+PE pleat
- Low Profile Aluminium Frame
- Face mount or recess mount with special attachment
- Horizontal or vertical sliding
- No tension springs or counter balances
- Stops at any position along the opening
- Smooth and easy to open and close
- Mesh retention system



REPLACEMENT
CARTRIDGES
AVAILABLE

Overview

The Monarch Window is a pleated mesh retractable Insect screen that is perfect for use on double hung, awning/casement, small servery and Bi-fold windows. Its 15mm pleated mesh and slimline Aluminium frame ensure sight lines remain minimal and simple. It is available in horizontal sliding or vertical pull-down operation both with the choice of face mount or recess mount installation.

The face mount option is ideal for use on windows where there is no room to install inside the reveal or window frame. Installation is via Double sided adhesive tape which eliminates visible fixing and speeds up installation.

There are no tension springs or counterbalances used to retract the screen making it smooth and light to operate.

Size Range

Single Slide **Max:** 1500mm high x 1300mm wide
2000mm high x 1000mm wide

Double Slide **Max:** 1500mm high x 2600mm wide
2000mm high x 2000mm wide

Pull Down **Max:** 1370mm high x 1370mm wide
(3 or 4 sided)

ORDERING INFORMATION

MONARCH WINDOW

VERTICAL SLIDING SASH				
Width Height	600-900	901-1200	1201-1370	1371-1500
up to 600	MWP-0609	MWP-0612	MWP-0613	*
600 - 900	MWP-0909	MWP-0912	MWP-0913	*
901 - 1200	MWP-1209	MWP-1212	MWP-1213	*
1201 - 1370	MWP-1309	MWP-1312	MWP-1313	*
1371 - 1500	*	*	*	*

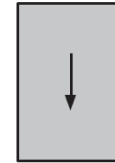

Pull Down

SINGLE SASH HORIZONTAL SLIDING					
Width Height	Up to 600	601-900	901-1200	1201-1500	1501-1800
600 - 900	MWS-0906	MWS-0909	MWS-0912	MWS-0915	*
901 - 1200	MWS-1206	MWS-1209	MWS-1212	MWS-1215	*
1201 - 1500	MWS-1506	MWS-1509	MWS-1512	MWS-1515	*
1501 - 1800	MWS-1806	MWS-1809	MWS-1812	MWS-1815	*



Single Panel

DOUBLE SASH HORIZONTAL SLIDING						
Width Height	1501-1800	1801-2100	2101-2400	2401-2700	2701-3000	3001-3300
600 - 900	MWD-0918	MWD-0921	MWD-0924	MWD-0927	MWD-0930	*
901 - 1200	MWD-1218	MWD-1221	MWD-1224	MWD-1227	MWD-1230	*
1201 - 1500	MWD-1518	MWD-1521	MWD-1524	MWD-1527	MWD-1530	*
1501 - 1800	MWD-1818	MWD-1821	MWD-1824	MWD-1827	MWD-1830	*

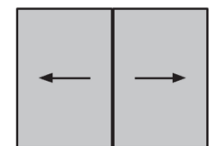

Double Panel

STANDARD FINISHES: MF - Mill Finish
BK - Satin Black
WH - White
CH - Champagne

ORDERING CODE: 4P Pull down 4 sided frame
3P Pull down 3 sided frame
SS Single Slide
DS Double Slide

NOTES: * Size not available. Custom colours available on request but subject to conditions.

SCREEN SELECTION

SELECTING THE RIGHT SCREEN FOR THE APPLICATION IS EASY

1. Determine the size of the opening that requires screening (refer below for information on How to Measure)
2. Check to see if there is enough room for the screen to be fitted in preferred location
3. Check to see if the door handle will have suitable clearance around the screen
4. Determine if the opening requires barrier free design (this is usually the case with all doors and outdoor rooms)
5. Determine if the screen is to be Single Slide or Double slide or pull down (it is recommended for screens sizes less than 2m wide to be single slide)

Once you have become familiar with the features and size limitations of each product type, the above information is generally all that is required to select the right screen for the application.

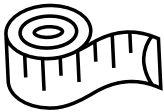

BEFORE MEASURING

Once you have determined the preferred installation method and screen type to be installed, proceed to measure the opening.

1. Select if the screen is to be installed within the door frame, reveal or to the face of the opening
2. Measure the tight opening size, it is recommended to use our how to measure guide (see page 15)
3. Ensure there is enough free space in the reveal or door frame to fit the screen and that the preferred location of the screen will not interfere with the door handles or locking bolts etc.
4. It is advisable that you measure left and right sides in the opening height as well as the top and bottom width and work on the mean average if the dimensions vary (refer how to measure form)
5. Check the opening for square and plum as you may have to make special allowances to square up the opening to make the screen operate efficiently. The Monarch EX 2 Screen has a built in tolerance of +/-10mm.

HOW TO MEASURE

The Monarch range of screens are designed to fit most openings; however there are a few important checks that must be carried out prior to ordering.

1. Ensure there is a minimum 5mm clearance between the screen and any window or door furniture (i.e. handles etc)
2. Make sure the structure is square within 10mm (note: out of square openings may affect the operation of the screen)

PLEASE TAKE NOTE

- Monarch EX2 the height must be 60mm taller than the width
 - Monarch Window and Monarch Lite recessed application take off 3mm of the overall height and width for all other screens, please do not take off any size deductions
3. Please take extreme care when taking measurements ensuring the screen will fit your opening
 4. It is not recommended to fit screens to rough or un-even surfaces, such as paving, stamped concrete, carpet or vinyl flooring. If you are fixing to rough or un-even flooring an aluminium sill plate must be installed first. But remember to include and make allowances into your height measurement.

DESIGN CONFIGURATION REFERENCE	
	SELECT THE DESIGN THAT BEST FITS YOUR SITUATION
PD4S	Pull down screen with bottom catch frame
PD3S	Pull down screen with no bottom catch frame
DS	Double sliding bi-parting from the centre
LL	Single sliding latch on the left (looking from the inside)
LR	Single sliding latch on the right (looking from the inside)

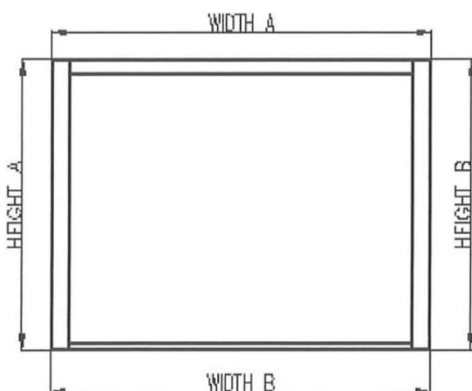

SCREEN SIZE		
Height A		Width A
Height B		Width B
Average (Height A + B / 2)		Average (width A + B / 2)

EXTRUSION PROFILES

MONARCH EX2

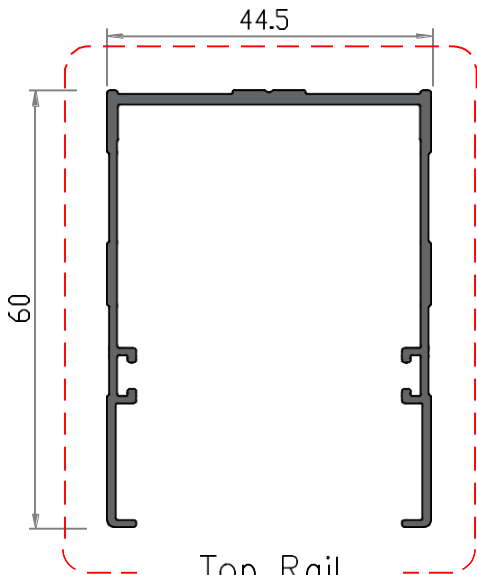

Top Rail
AL-S39378

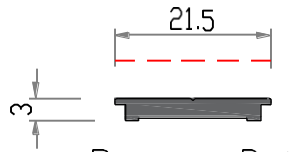

Bottom Rail
AL-S39374

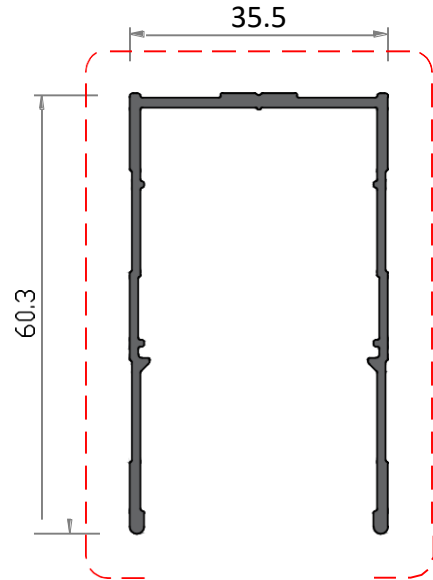

Screen Housing Cover
AL-S39376

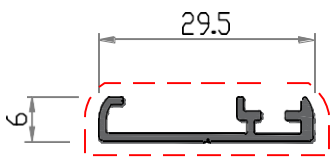

Catch Frame
AL-S39377

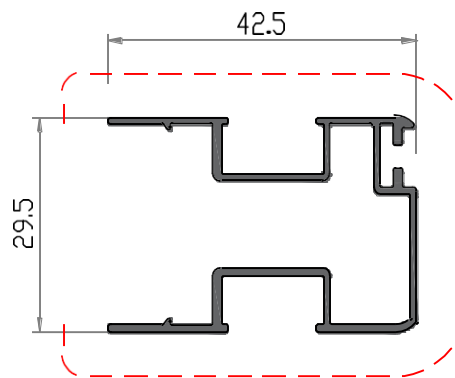

Sliding Bar
AL-S39375

EXTRUSION PROFILES
MONARCH GLIDE

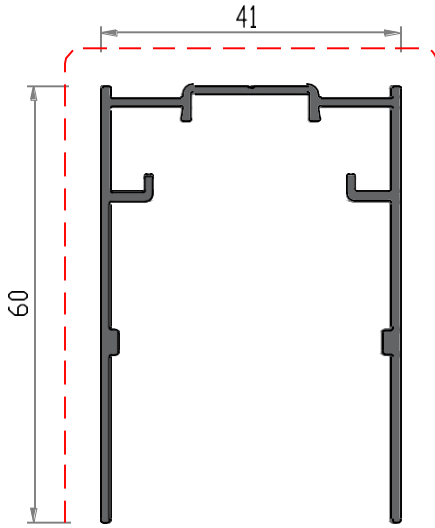

Top Rail
AL-S45743

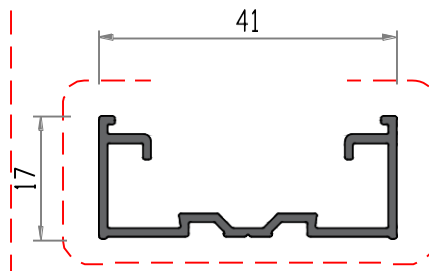

Bottom Rail
AL-S45744

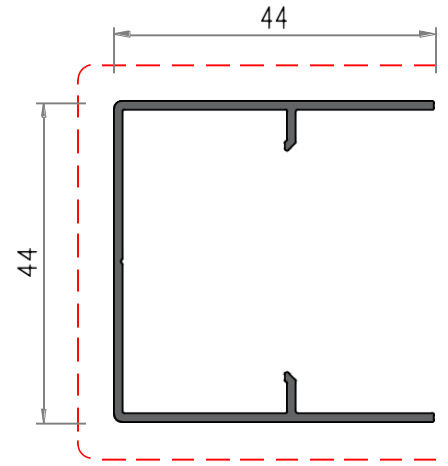

Housing
AL-S45740

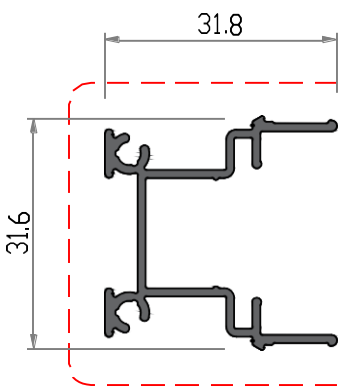

Inner Cartridge
AL-S45822

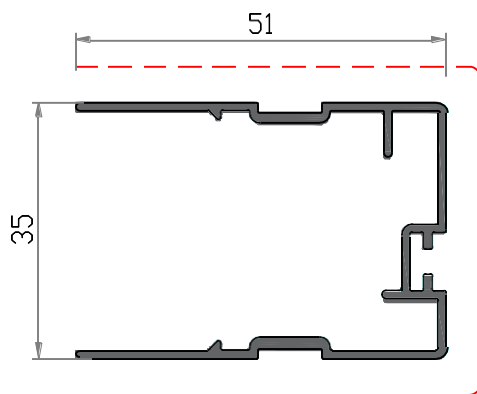

Sliding Bar
AL-S45471

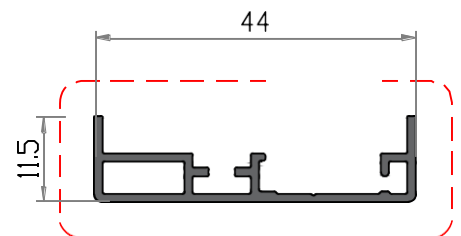

Catch Frame
AL-S45472

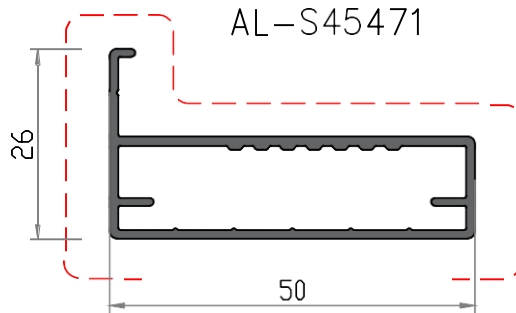

Face Mount Attachment
AL-S47154

EXTRUSION PROFILES

MONARCH LITE

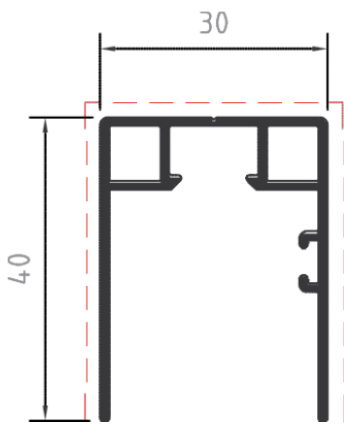

Guide Rail 40mm

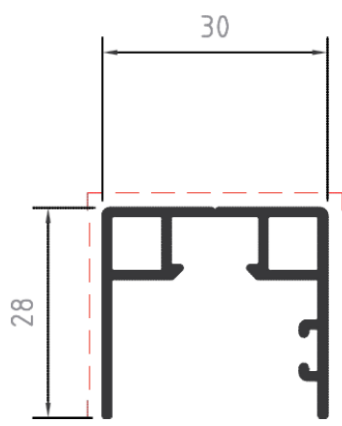

Guide Rail 28mm

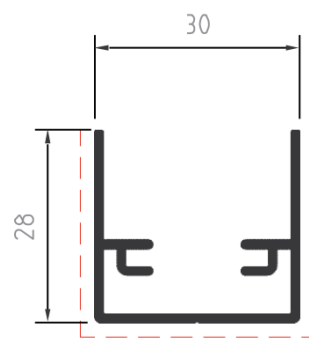

Housing 28

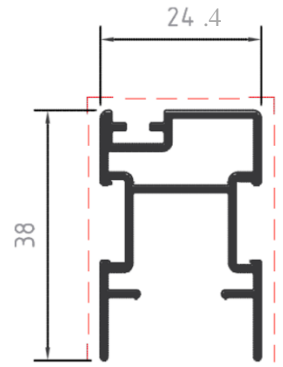

Sliding Bar 38

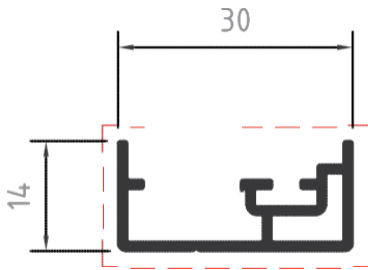

Catch Frame 14

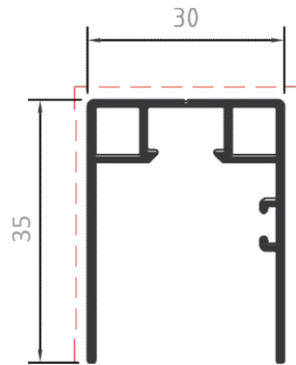

Guide Rail 35

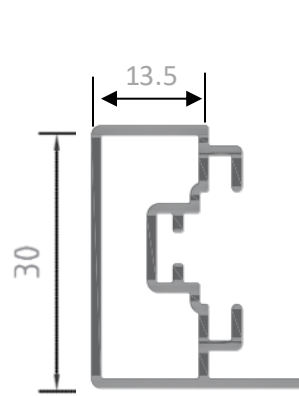

Screen Frame

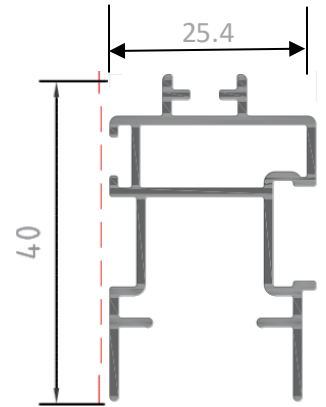

Sliding Bar

Monarch Lite Face Mount Profiles

MONARCH WINDOW

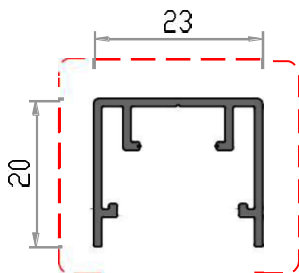

Guide Rail

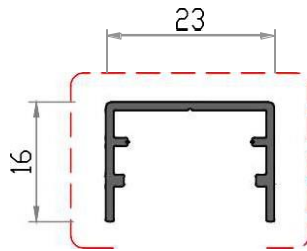

Frame

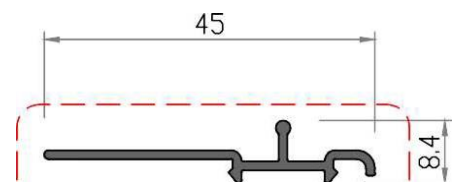

Sliding Bar Cover

TECHNICAL SPECIFICATIONS

MONARCH EX2

Material:	P.E.T
Mesh Aperture:	20 x 20
Pleat Width:	20mm
Yarn Type:	Monofilament
Production Process:	Woven

MONARCH GLIDE

Material:	P.E.T
Mesh Aperture:	20 x 20
Pleat Width:	25mm
Yarn Type:	Monofilament
Production Process:	Woven

MONARCH WINDOW

Material:	PP+PE
Mesh Aperture:	20 x 20
Pleat Width:	15mm
Yarn Type:	Monofilament
Production Process:	Woven

MONARCH LITE

Material:	PP + PE (core: PP and Sheath :PE)
Mesh Aperture:	20 x 20
Pleat Width:	20mm
Yarn Type:	Monofilament
Production Process:	Woven

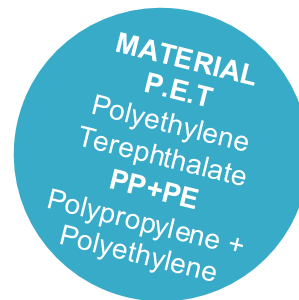

INSTALLATION TAPE

Monarch Screens are supplied with a range of adhesive tapes that assist with installation. Below is a schedule detailing the type of tapes, if and when they are pre-installed.

MONARCH EX 2

Mill Finish

- White tape - pre-attached onto the Bottom Rail.
- Red tape - supplied with a small roll in each carton.

For other finishes:

- White tape - pre-attached to Bottom Rail.
- Red tape - pre-attached to aluminium profiles.

MONARCH GLIDE

- Natural Anodised matt orders (also used for special powder coat colours)
- Red tape installation tape is supplied with a small roll in each carton.
- Blue tape supplied with a small roll in each carton.

For other finishes:

- Red tape is pre-attached.
- Blue tape is pre-attached onto the Bottom Rail

MONARCH LITE

- Blue tape supplied with a small roll in each carton.

MONARCH WINDOW

- Blue tape supplied with a small roll in each carton.

WARRANTY STATEMENT

SEIKI SCREEN SYSTEMS

www.seikiscreensystems.com

PRODUCT WARRANTY

The following warranty is provided by the manufacturer of the goods. The manufacturer shall not be bound by nor be responsible for any term, condition, representation or warranty other than that which is given by the manufacturer of the goods. On the terms set out below, the manufacturer warrants that the goods are supplied free of manufacturing defects. The warranty applies exclusively to non-wearing components and that the products to be free from defects for 5 years from the date of purchase. Screens installed in external applications carry a 2 year warranty from the date of purchase.

Damage caused by misuse, normal wearing of cord and track and mesh components or use of other than residential applications, accidents and act of god can not be claimed under this or any other warranty. Mesh retaining hooks, where installed, are a wearing component and as such do not carry any warranty as they are designed to break and fatigue as part of the product design. Except as provided herein, there are no other warranties whatsoever, express or implied, as to performance, characteristics, specifications or conditions of the product, including but not limited to merchantability or fitness for purpose.

Where such limitation of liability is not prohibited or void under any applicable legislation, liability for any loss or damage whatsoever (including consequential and economic loss) and howsoever arising (including but not limited to contract, tort and negligence) directly or indirectly in connection with their products or supply thereof, shall be limited to any one or more of the following as determined by the manufacturer in absolute discretion.

Seiki Screen Systems assumes no liability under the warranty for the following:

- Misuse, abuse, accidental or intentional damage
- Exposure to windy conditions (max wind speed 7m/s)
- Where regular cleaning and maintenance has not been carried out
- Improper adjustment or operation by the purchaser
- Improper maintenance or installation
- Fading and deterioration of surface finish where regular cleaning has not been carried out
- Damage caused by dirt and debris that have not been removed from tracks and channels,
- Inaccurate or incorrect site or operational specifications,
- Unauthorised repair or modification,
- Progressive deterioration caused by exposure to sun, rain, air borne pollutants heat and or cold.
- Normal wear and tear of mesh and moving components,
- Use contrary to the purposed as to which it is designed,
- Failure to retract the mesh for extended periods of time resulting in flattening of the mesh.
- Use of replacement parts other than authorised parts
- Damage caused through accidental impact by pets or humans
- Damage caused by exposure to heat, flames, sparks and ash

RECOMMENDED MAINTENANCE

Screen systems are a combination of many different substrates and therefore will be susceptible to normal wear and tear from the environment. Dirt, grime; air borne pollutants and salt deposits can affect the performance and appearance of screens.

Cleaning of the screen must be carried out at frequent intervals. The frequency of cleaning will depend on the environment in which they are installed. Please refer to the Owners Manual for details.

By law, this warranty is the exclusive warranty granted by the manufacturer and is in lieu of all other express or implied warranties or guarantees. There are no implied warranties as to the merchantability, quality or fitness for a particular purpose.

OWNERS MANUAL CARE AND MAINTENANCE

IMPORTANT NOTE

Before operating your screen please review this manual. Keep this manual in a safe place for future reference. If issues arise that require information not found in this manual contact your screen supplier.

CAUTION

- Do Not lean or push against the mesh.
- Keep children a safe distance from the screen.
- This screen is not intended as a security device.
- Care should be taken as pets can damage the mesh.
- Do not expose to open flames, sparks or intense heat.

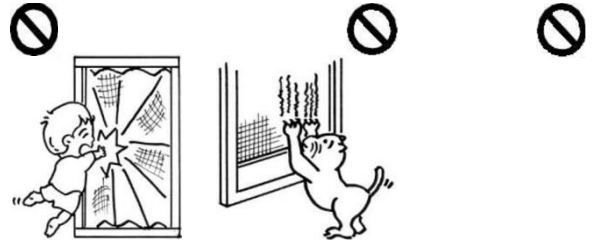

HOW TO USE

To open and or close the screen, gently pull or push the Sliding Bar to the desired position. For best performance use the handle or the Sliding Bar and operate at waist height.

The screen should be operated at a slow pace. Do not slide the screen with excessive force. The Sliding Bar operates manually, and should slide with ease.

If the mesh becomes rumbled/wrinkled, completely close over the screen, then cycle the Sliding Bar in both directions until the pleats are straightened.

When sliding the screen check to see if the hooks are moving freely. If the hooks are catching on the mesh bend down and straighten them before continuing to operate the screen.

Do not leave your screen open for extended periods of time. Return the screen to the canister when not in use, this will help keep the mesh protected and help maintain the shape of the pleats.

Do not use the screen during heavy winds and keep it safely stored to avoid damage. If your screen is open in heavy winds assist the closing operation by placing your hand against the mesh.

The "optional" mesh hook assists in holding the mesh in place when exposed to moderate winds. If undue force is applied by high winds or accidental impact the hook is designed to help protect the screen.

In the event that the hook has released reattach any loose hooks to the bottom tension cord before operating the screen.

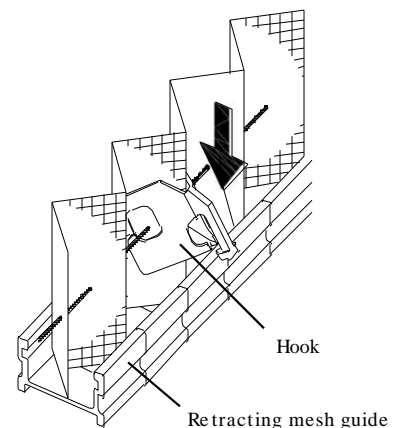
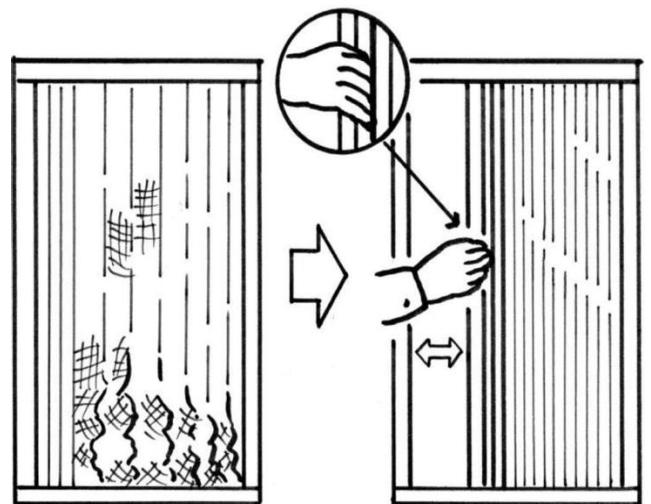

Monarch EX2 Shown

OWNERS MANUAL CARE AND MAINTENANCE

CLEANING

Accumulation of dust, debris, and pet hair may cause the screen operation to become heavy and tight. Keep the Bottom Rail free of such debris. After cleaning spray the Bottom Rail with silicone spray.

If the mesh accumulates excessive dust or debris remove it gently with a soft duster brush, then wipe the mesh using a damp microfiber cloth. Place your hands on either side of the mesh and wipe vertically along the pleat line as if kneading it. Do not apply excessive force, and rinse with a gentle spray of clean water.

To wash the screen, wipe using a damp cloth soaked in lukewarm water and mild detergent, then rinse using a damp cloth soaked in clean water.

Cleaning of the screen must be carried out at frequent intervals. Failure to carry out regular maintenance may exclude the application of this warranty. The frequency of cleaning will depend on the environment in which they are installed.

Cleaning of the screen must be carried out at frequent intervals. Failure to carry out regular maintenance may exclude the application of this warranty. The frequency of cleaning will depend on the environment in which they are installed. The following maintenance levels are recommended for maintaining the screens optimal operational condition.

ENVIRONMENT TYPE

Mild - Rural and domestic areas: minimum every 6 months

Moderate - Cities and light industrial areas: minimum every 3 months

Severe - Coastal and heavy industrial areas: minimum every month

CAUTION

After washing, dry the screen with a soft cloth before operation.

Do NOT scrub the mesh or the frame with a wire with course brushes.

Do NOT use thinner, benzene, alcohol, cleanser, acid / alkaline or otherwise harsh detergents on the screen, these substances will permanently damage the mesh.

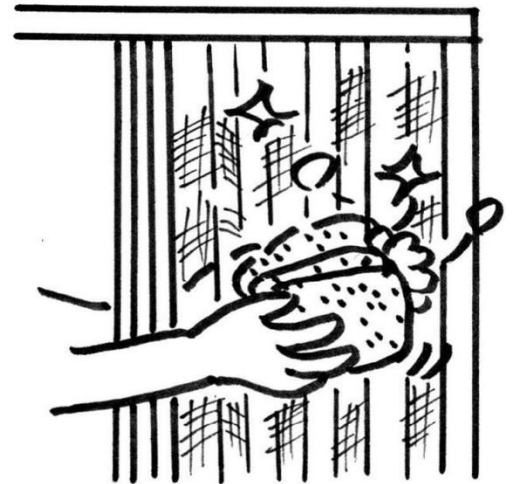
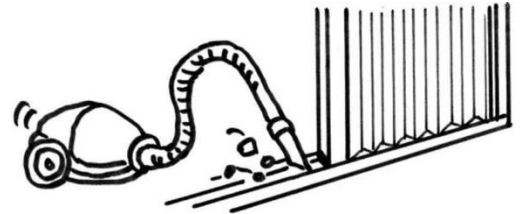

WIND LOAD FOR MONARCH SCREENS

Monarch Screens have been tested for wind load resistance and the following details are the results of testing and some practical tips to protect from wind load damage. The official wind load test for the Monarch Exscreen is 6m/s or 21.6 km per hour or 13.6 knots. The test is based on applying constant wind pressure and the duration time this load was applied is not recorded.

This is considered a relatively strong wind load. The performance of the screen will depend largely on the overall size of the screen. At a wind load of 25km/h the mesh will bellow (bend) excessively, a bit like a sail on a yacht. The butterfly clips (if installed) at the bottom of the screen will hold fast but if the wind conditions are gusting, the clips may release. This is actually is a good thing as the mesh coming loose releases loading on the mesh and reduces potential damage.

Items to note regarding wind load. The location of the screen on the building will have an effect on performance.

For Example, if the door is on or near the corner of the building the wind load could be up to 1.5 times higher at that location compared to the middle of the building. What may be considered as mild wind, in reality the wind load is considerably higher at the corners of the structure compared to that of the centre of the building.

There is also the tunnel effect that increases wind load; this usually occurs when you have a small entry door at one side of the building and a larger opening opposite. The air volume is increased, thus more wind load is applied to the screen. When it comes to wind load, if the conditions are such that you would close your curtains or blinds to protect them from being damaged, then you should retract your screens to protect them from damage also. Generally during windy conditions insects are usually not prevalent thus the need for insect protection is reduced.

When retracting the screen in heavy winds, use your hand to support the mesh while retracting the screen, this will reduce the load on the screen making it easier to slide and assist with the butterfly clips (if installed) not catching during the retracting process.

TEST REPORTS AVAILABLE ON REQUEST





NZ Trade Distributor
www.omastream.com

Insect Screen Systems

The Monarch range of retractable screens by Seiki are the market leader in providing an extensive and diverse range of technologically advanced pleated insect screening solutions to suit any living environment.



seikiscreensystems.com
See The Difference. Feel The Breeze.